







# Thule Rapid System Kit 1663



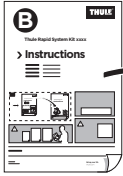
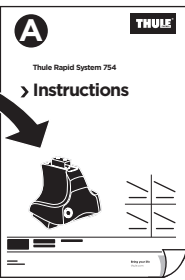

## > Instructions

RANGE ROVER Evoque, 3-dr SUV, 11-

RANGE ROVER Evoque, 5-dr SUV, 11- / \*12-

\*North America

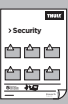

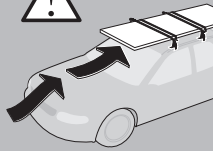
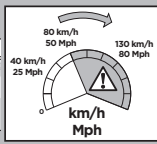

80 km/h 50 Mph	130 km/h 80 Mph
40 km/h 25 Mph	
km/h Mph	



xx kg  
xx lbs

+



7 kg  
15,4 lbs

+



3 kg  
6,6 lbs

---

=	3-dr	Max. 40 kg	Max. 88 lbs
=	5-dr	Max. 50 kg	Max. 110 lbs

ISO 11154-E

141663

C.20151002  
519-1663-04

Bring your life

thule.com



271 x2



1356 x2



x1

323 x2

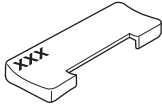

1187 x2

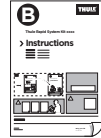

x1

1

	X (scale)	X (mm)	X (inch)
<b>RANGE ROVER Evoque</b> , 3-dr SUV, 11-	47	1121	44 <sup>1</sup> / <sub>8</sub>
<b>RANGE ROVER Evoque</b> , 5-dr SUV, 11- / *12-	47	1121	44 <sup>1</sup> / <sub>8</sub>

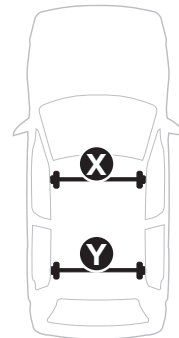
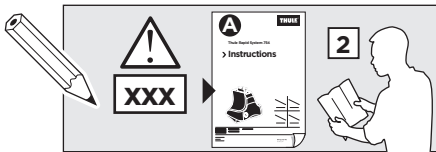

	Y (scale)	Y (mm)	Y (inch)
<b>RANGE ROVER Evoque</b> , 3-dr SUV, 11-	46,5	1116	43 <sup>7</sup> / <sub>8</sub>
<b>RANGE ROVER Evoque</b> , 5-dr SUV, 11- / *12-	46	1111	43 <sup>3</sup> / <sub>4</sub>

2

SRA

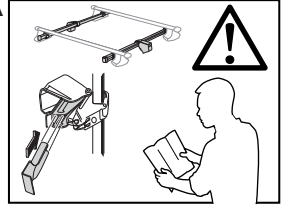

RANGE ROVER Evoque, 3-dr SUV, 11-

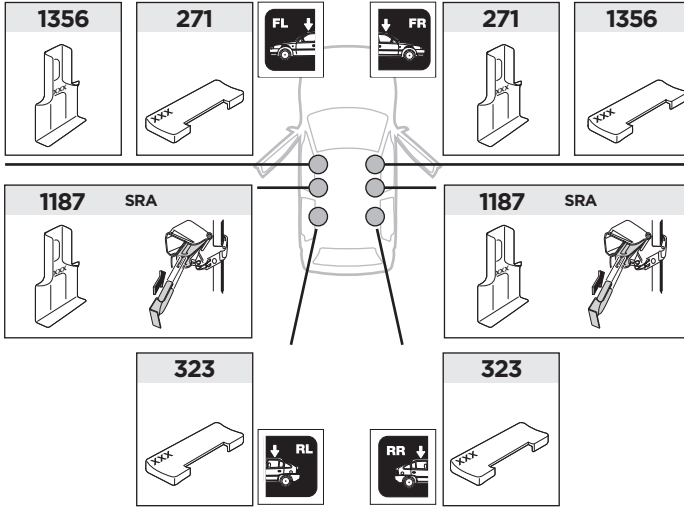

RANGE ROVER Evoque, 5-dr SUV, 11- / \*12-

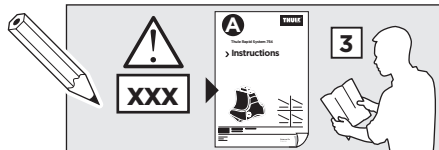
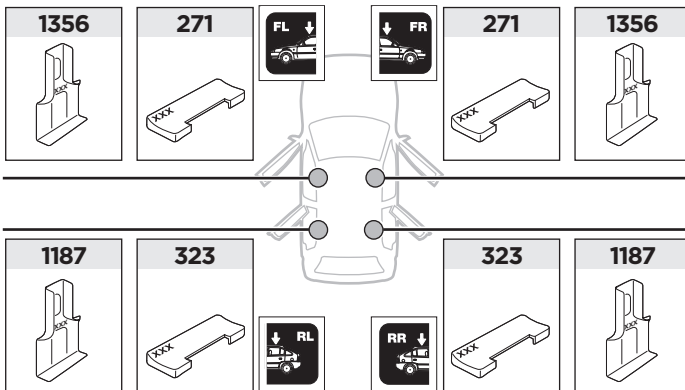

3

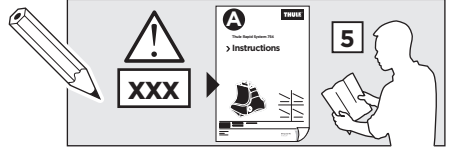

	W (mm)	Z (mm)	Y (mm)	W (inch)	Z (inch)	Y (inch)
<b>RANGE ROVER Evoque, 3-dr SUV, 11-</b>	<b>270</b>	<b>650</b>	<b>340</b>	<b>10 5/8</b>	<b>25 5/8</b>	<b>13 3/8</b>

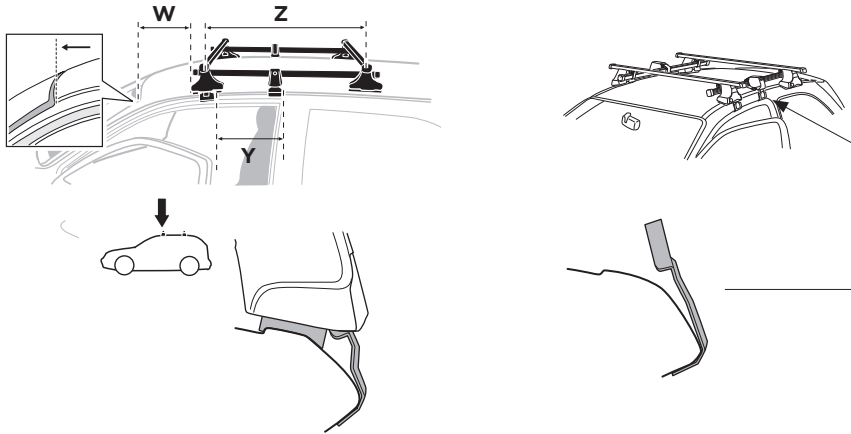

	W (mm)	Z (mm)	W (inch)	Z (inch)
<b>RANGE ROVER Evoque, 5-dr SUV, 11- / *12-</b>	<b>270</b>	<b>700</b>	<b>10 5/8</b>	<b>27 1/2</b>

